



TB 
Display Systems

TB Frame

PRODUCT BROCHURE - V3

Designed and Produced by
TECNA DISPLAY LTD

T3 Frame

THE ORIGINAL MODULAR FRAMEWORK SYSTEM.

T3 Frame is renowned for its patented, modular twist lock assembly method. Developed to be one of the most versatile and innovative solutions in the creation of display units. From dynamic and engaging exhibition environments to point of sale units and conference sets; T3 Frame can be used to fulfil every need.

A wide range of accessories and varied extrusions allows for innovative and versatile display solutions.

When it comes to T3 frame it's a simple...

TWIST LOCK & CONNECT



KEY FEATURES

- NO TOOLS REQUIRED FOR ASSEMBLY OR DISMANTLING OF DISPLAYS
- SUPPORT MULTIPLE GRAPHIC TYPES.
- DEVELOP INITIAL STANDS INTO MORE ELABORATE DESIGNS
- MODULAR CONCEPT FOR EASY STORAGE AND TRANSPORTATION
- RECONFIGURABLE AND REUSABLE PROFILES AND COMPONENTS
- DESIGNED TO CARRY A WIDE VARIETY OF MEDIA.
- MULTIPLE ACCESSORIES

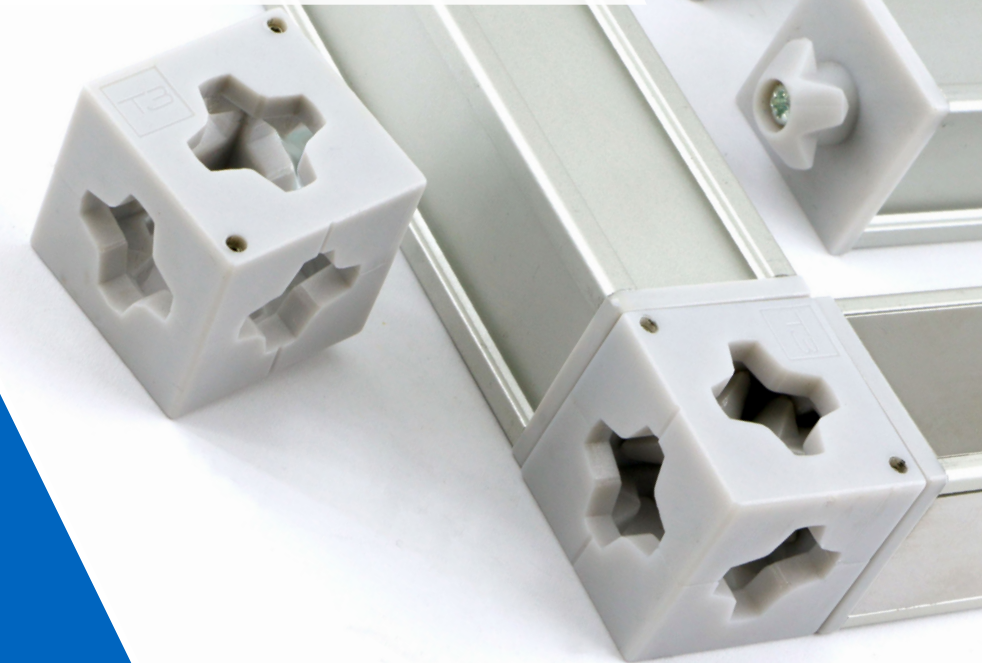

FEATURES

WHY USE T3 FRAME?

T3 Frame is one of the most innovative and versatile display frameworks available in the industry. With a host of unique benefits and features.....

EASY TO TRANSPORT & STORE

The entire range is modular. Large scale designs can be flat packed and stored efficiently into a range of cases and bags. Saving on logistical and storage costs.



CUSTOMIZABLE

Our profiles are produced in either standard or custom sizes. This provides complete product and system flexibility.



NO TOOLS

The patented and famous twist lock assembly method means that no tools or levers are required to assemble T3 Frame solutions.



FAST BUILD TIMES

Due to its modular design and tool free assembly, structures take a fraction of the time to build. Saving on labour costs.



LIGHTWEIGHT DESIGN

Developed to be a strong and lightweight solution, allowing for costs to be saved on packaging and transport.



MODULAR COMPONENTS

The framework system has been designed as a modular solution. This allows for displays to be reconfigured and redesigned efficiently.



T3 DEMO KIT

Get a hands on feel for T3 Frame. The kit provides a simple understanding of how our patented system works.



KEY FEATURE

T3 Frame is also suitable for outdoor exhibitions, using additional clamps and counterweights.

STRUCTURES

CREATING FUNCTIONAL AND AESTHETIC STANDS HAS NEVER BEEN THIS EASY.

T3 Frame can be used to create all manner of displays while remaining cost effective and simple to assemble. From custom curves to hanging units, T3 Frame has no design limits and consistently delivers successful solutions.

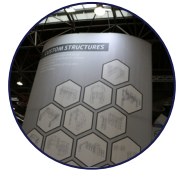

TOWERS

The T3 Frame allows for structures of up to 6 metres high to be built. Modularity allows for tall structures to be raised in sections quickly and safely.



DOORS

Our variety of doors can be fitted in standard or custom sizes. Allowing for storage rooms and private meeting areas to be incorporated into any design

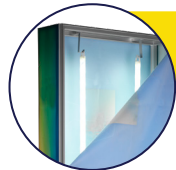

WANDLITE

Incorporate illuminated walls for vivid lighting and effective message delivery. T3 Frame allows for almost any size of wall to be designed and illuminated.



LITEBOX

Providing double sided illuminated lightboxes or counters. Powering up to 50 bulbs with one mains plug results in custom Lightbox solutions up to 3.5 x 4m wide. Easy to change graphics allow for promotional messages to stay current.

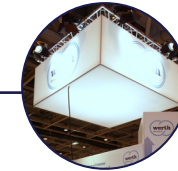
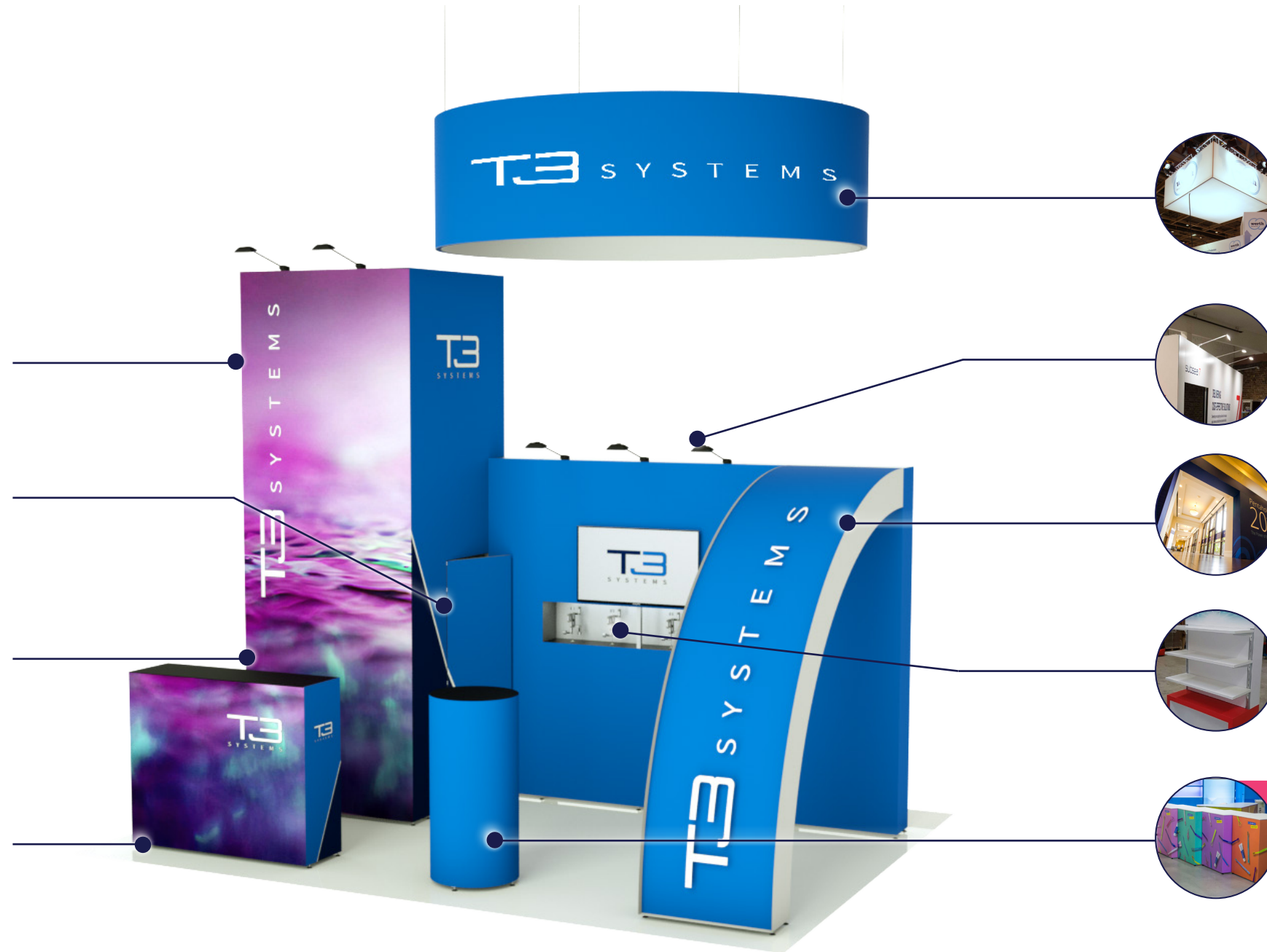

HANGING BANNERS

Strong and lightweight profiles coupled with multiple extrusions for graphic mounting results in T3 Frame being used on many occasions for hanging banners and signs. Our custom curved profiles allows for circular signs to be created.



LIGHTING

T3 Frame allows for multiple variations of plinths and counters to be made. The modular design allows for these to be reconfigured and redesigned for other purposes.



ARCHES & BEAMS

Our curved and vertical profiles allow for all manner of arches and beams to be created. These are effective for exhibition entrances and creating private event areas.



SHELVING

Shelving units allow for products and literature to be displayed effectively. T3 Frame boasts 4 separate methods for supporting shelves. Attach TV mounts and hooks for the inclusion of multimedia displays.



EASYCUBE

Allows for multiple variations of plinths and counters to be made simply. Using accessories like clamps and double joiners, separate units can be connected and used together.

PROFILES

OUR PROFILES ARE AT THE CORE OF OUR INNOVATIVE AND VERSATILE FRAMEWORK.

The range of profiles are designed to create a solution for every display need, functioning with the same modular design and simple Twist & Lock assembly.

AIRFRAME

The original seamless profile. Designed to carry all types of roll up or rigid panel graphics using magnetic or Velcro tape.

CHANNEL

Created to capitalise on the market for fabric graphics with silicon edging. The channel on all sides allows for multiple extrusions to be utilised.

FUSION

Combines the best of both the Airframe and Channel profiles. This is our most versatile and popular profile as it can be used for any graphic type.

ULTRALITE CHANNEL

A plastic version of the channel profile. Used predominantly to create lightweight structures suitable for most graphic applications

ULTRALITE FUSION

A plastic version of the fusion profile. used predominantly to create lightweight plinths and counters in both rigid and fabric graphics.

FLEXI- FRAME

A flexible profile used to create display walls that can be manipulated into multiple shapes and orientations. Magnetic roll up graphics only.

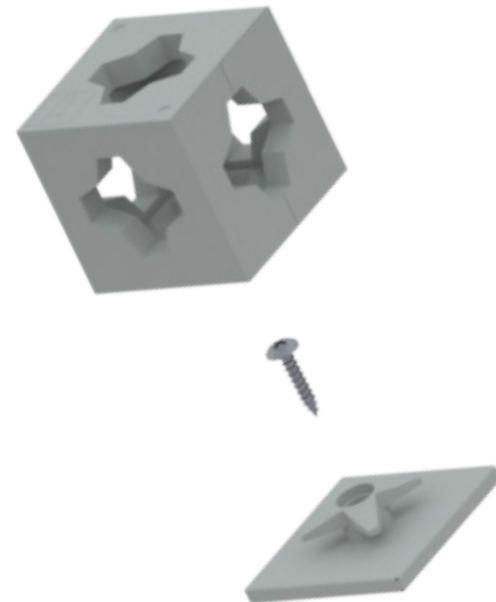

EXTRUSIONS

EXTRUSIONS FOR UNLIMITED GRAPHIC AND STRUCTURAL FLEXIBILITY.

The range of T3 Frame extrusions are each designed with a particular solution in mind. From the mounting of graphics to the incorporation of shelves and doors there is an extrusion to fulfil every need.

45° SILVERLITE

This extrusion is specifically designed for the mounting of textile/fabric graphics with silicon edging. It offers a closer, virtually seamless finish for the edges of all textile structures.

COMB

This extrusion is specifically designed when joining multiple fabric graphics. It provides a virtually seamless join and allows for large format fabric to be printed into smaller more manageable sizes without compromising the actual image.

SHELF BRACKET

This extrusion is specifically designed for the inclusion of shelving into your structures. The channels in the extrusion allows for the shelving hooks to be placed anywhere on the upright profile.

MULTIUSE (CHMUIC)

Designed to allow for the mounting of graphics in an internal corner. Can be fitted with either Velcro or steel finishing used when mounting rigid board or roll up graphics.

DOUBLE SLIDING DOOR

This extrusion allows for sliding doors to be incorporated into any structure. Providing a unique solution to storage and presentation cases.

PANEL SHELF

This extrusion allows for the simple installation of most shelving types into any structure.

i INFO

FITTING OF EXTRUSIONS

Each extrusion is designed to fit easily into the channel of a profile. The extrusion is secured with a bayonet end fitting.

GRAPHICS

FINISH YOUR DISPLAY WITH VIBRANT GRAPHICS.

The T3 Frame system is able to support any graphic type available within the display industry. Due to the variety of combinations between profiles and extrusions it can be configured to accommodate multiple graphic types at a time.

TEXTILE

T3 Frame can be used to carry all textile or fabric graphics. Using our Silverlite extrusions, it allows for the silicon edging of the graphic to be fitted quickly.

Common profiles used: **FUSION, CHANNEL**

ROLL UP

T3 Frame can be used to carry all manner of roll up graphics. Profiles are fitted with either steel or Velcro tape with the graphic then being fitted with opposing Velcro or magnetic tape.

Common profiles used: **AIRFRAME**

RIGID BOARD PANELS

T3 Frame can be used to carry rigid panel graphic easily. Profiles can be fitted with Velcro to ensure the panels stay securely to the frame.

Common profiles used: **AIRFRAME**



SHELL CLAMP CODE: SHCLMP

Allows for the T3 Frame to be combined with various other framework systems. Also enables for the T3 Frame to be mounted onto any surface.

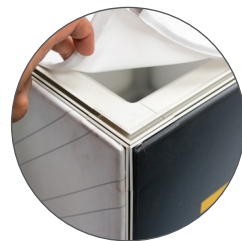

SEAMLESS EDGE

Our 45° Silverlite allows for a virtually seamless finish to be created.

RETAIL

MULTIPLE ACCESSORIES FOR EVERY DISPLAY NEED.

The T3 Frame system has a variety of accessories that will help compliment or give extra functionality to any display structure. (View our catalogue to find more accessories that are available)



BAGS AND CASES CODE: CCL

Various branded bags and travel cases are available. Structures can be dismantled and packed into these cases for compact transportation and storage.



WHEELS CODE: FWB50 / S

Structures can be moved quickly and easily by simply rolling the unit. Lockable wheels are also available.



SHELF SUPPORT TWIST IN CODE: CHSST

Provides a support mount for shelving and the installation of T3 Wandlite tubes. Twisting directly into the channels of T3 Frame profiles. They can be applied on an adhoc basis.

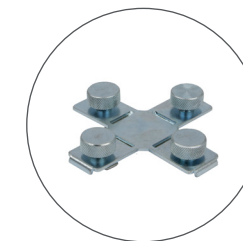

RIGIDISERS CODE: SCLMPX

Reduces stress on the connection between profiles and connectors. Comes in various configurations for multiple uses.

MODULARITY

RECONFIGURE AND REUSE

Part of the T3 Frame's unmatched versatility is the ability to be reconfigured and re-purposed for other projects and designs.

The modular design allows for new displays to be built easily by simply adding or removing profiles and components.

HOW IT WORKS

The below parts list showcases the products required to build the featured stand. From the original list of parts the following 6 stands can be created without the need for additional parts.

EXAMPLE

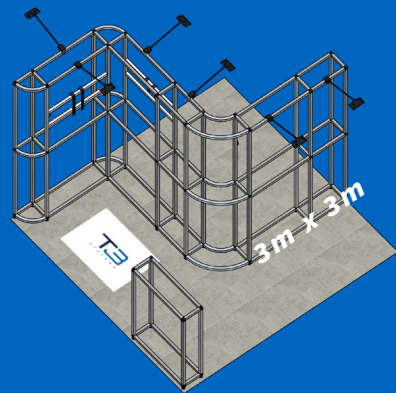

EXTRUSIONS

- Airframe Curve - 0490-90° - 9
- Airframe Curve - 0980-90° - 3
- Fusion Tube - 0245 - 31
- Fusion Tube - 0490 - 12
- Fusion Tube - 0857.5 - 22
- Fusion Tube - 1225 - 36
- Channel twist lock - 0857.5 - 4

ACCESSORIES

- Connectors - 56
- Monitor Support Hook - 2
- L.E.D Spotlights - 6
- Adjustable Shelf supports - 4
- 38mm Static Feet - 20



JUST SOME OF THE CONFIGURATIONS..

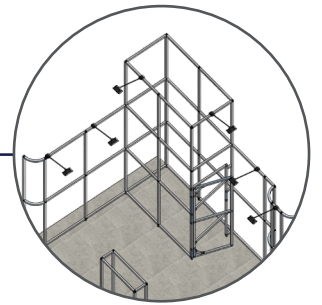
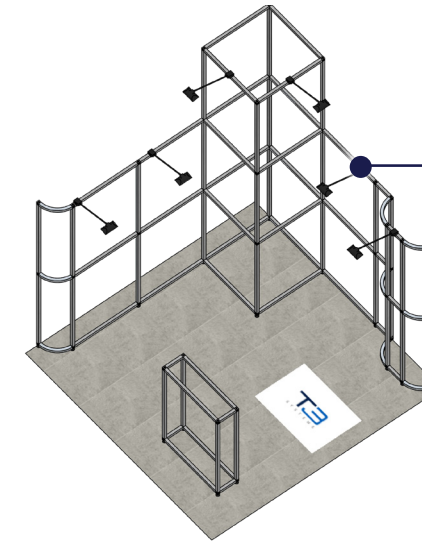
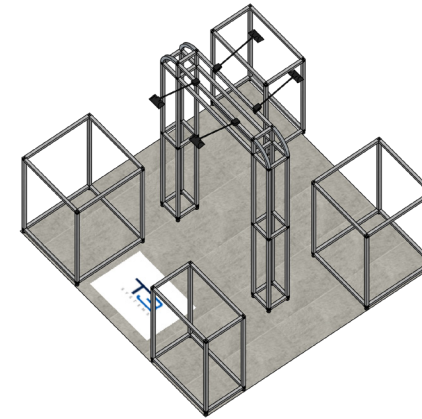
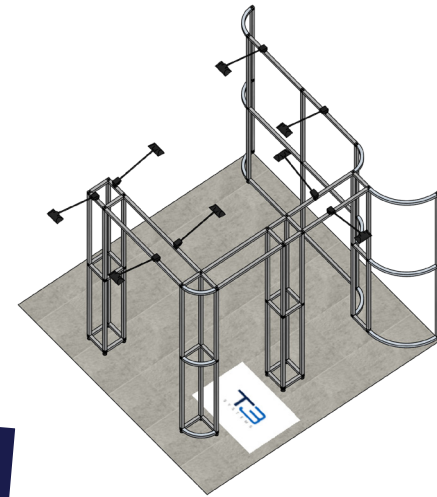

EXTEND YOUR STORAGE

Reconfigure the amount of storage space that you have by adding more profiles

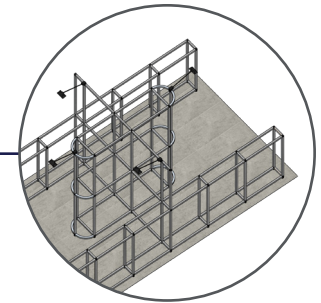
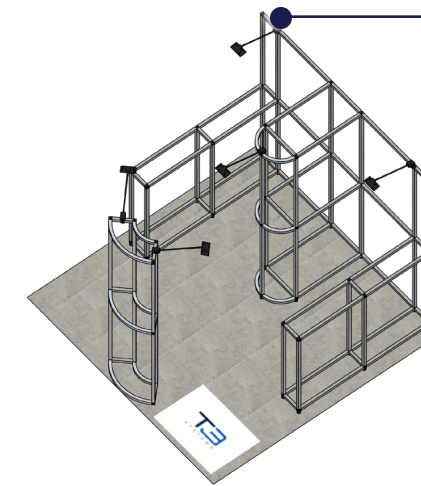
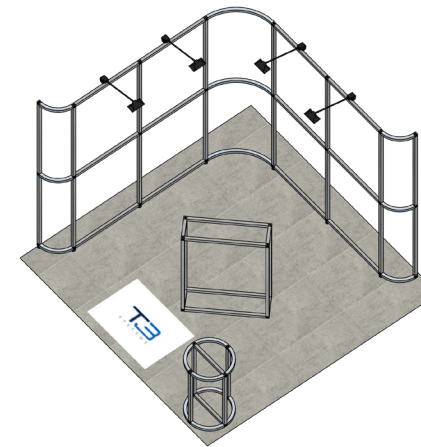
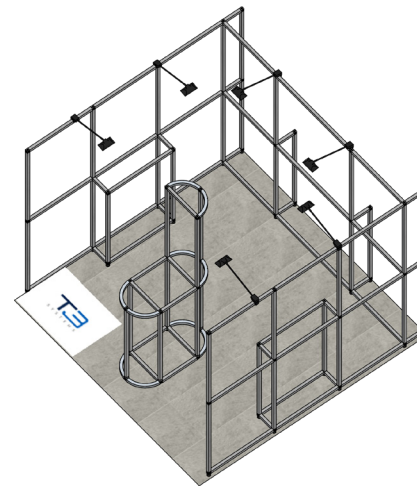

BOOTH EXTENSION

Create a double sided booth allowing for multiple brands to exhibit

EXHIBITIONS & CONFERENCES

EXHIBITIONS

This modular framework is designed for all manner of exhibition requirements. The unique concept allows for the creation of standard structures as well as more elaborate designs. Staying true to the cost effective core; T3 Frame provides simple installation, efficient storage and transport. A wide variety of successful projects is proof that T3 Frame is the ideal exhibition partner.

CONFERENCES

Creating large display walls that are ideal for conferences and meetings is simple with T3 Frame. With its customizable profile lengths, multiple graphic options and unique modular design these structures can be easily transported into hotels or conference rooms. With an added bonus of being compatible with the T3Wandlite, all your structures can be easily illuminated to add an extra wow factor to your graphics.



LIGHTING

CODE: SPLCHR/BLCK

Illuminate your structures with our range of LED spotlights

T3 WANDLITE

T3 Frame can easily be integrated with T3Wandlite and allows for bright and effective illumination of all displays and structures



KEY FEATURE

T3 Frame structures can be built to heights of 6 metres. Consult with our team for correct support and bracing configurations.

POINT OF SALE

With its patented twist lock, no tools assembly it is an ideal system for point of sale units. Created in a matter of minutes and relocated to new venues simply and easily. Users can adapt their displays quickly with our wide range of accessories. Resulting in display solutions that can be used for multiple occasions without having to undertake a complete redesign and build.



T3 LITEBOX

Add a T3Litebox to your point of sale display for an easy to update, effective promotional display

i INFO

Large projects have a build sequence with clear instructions on how to assemble the design



RETAIL

Classic retail displays need frequent updates in order to keep up with current market trends and designs. The T3 Frame system allows for this to be done with a simple Twist & Lock. Displays can be reconfigured and reused efficiently without the need for a skilled work force. Promotional graphics can be quickly interchanged keeping displays up to-date. With retail accessories such as slat walls, multimedia displays and our various retail extrusions creating custom built display is a simple process.



T3 EASYCUBE

For ideal retail structures, the T3 Easycube solution provides quick to assemble, versatile designs that can be configured to any floor space.

MUSEUMS & EXPERIENTIAL

MUSEUMS

T3 Frame can be used to create multi faceted museum displays, with its broad range of graphic options and the application of multimedia displays. The framework allows for the creation of purpose built display cases to house artefact and exhibits as well as display alcoves in large back walls.

EXPERIENTIAL

Use T3 Frame to think outside of the box. With its unmatched design potential it can be used to create various technology driven displays. Used as a platform to support virtual reality, projection mapping and photobooth technology can be implemented seamlessly. Its lightweight design allows for hanging banners and archways to be create to make a lasting impression on viewers.



MONITOR SUPPORT HOOKS

CODE:MSH

Add TV monitors to your display to boost client interaction

T3 AFFINITY

Combine T3 Frame with T3 Affinity using the T3 Adapter. This combination enables for extra versatility.



KEY FEATURE

The simple twist, lock and connect functionality allows for the structures to be built in a matter of minutes.

GET IN TOUCH



EMAIL

sales@tecnadisplay.com



CALL

UK OFFICE: +44 (0)208 803 4469

USA OFFICE: +1 (310) 299-2789



WWW.T3SYSTEMS.COM

